

## Linear Unit MTJZ 80

The MTJZ series contains Z-axis linear units with toothed belt drive, integrated ball rail system and compact dimensions. This linear units provide high performance features such as, high speed, good accuracy and repeatability by vertical applications.

In the linear units MTJZ is used a pre-tensioned steel reinforced AT polyurethane timing toothed belt. In conjunction with a zero-backlash drive pulley high moments with alternating loads with good positioning accuracy, low wear and low noise can be realized.

The in the profile slot driving timing belt protects all the parts in the profile from dust and other contaminations. The drive block provides the possibility to attach a motor or gearbox housing and additional accessories on it.

For CAD-files please contact Rollco.

Dimensions in mm.

**Modulus of Elasticity:**  $E = 70000 \text{ N / mm}^2$

**Operating Temperature (°C):** 0 ~ +60 For operating temperature out of the presented range, please contact Rollco.

**Duty Cycle:** 100%

**Max. Acceleration (m/s<sup>2</sup>):** 70

**Max. Travel Speed (m/s):** 5



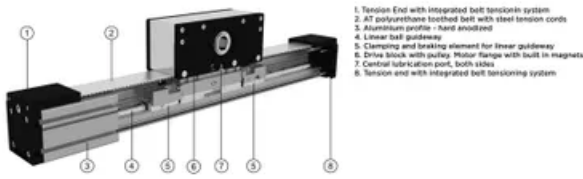

1. Tension End with integrated belt tensioning system
2. AT polyurethane toothed belt with steel tension cords
3. Aluminium profile - Hard anodized
4. Linear ball guideway
5. Clamping and braking element for linear guideway
6. Drive block with pulley Motor flange with built in magnets
7. Central lubrication port, both sides
8. Tension end with integrated belt tensioning system

## Deflection of the linear unit

### MTJZ

Fixed - fixed mounting

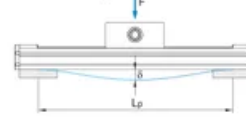

Fixed - free mounting

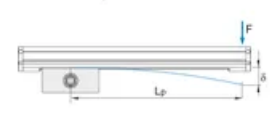

- delta: Maximum deflection of the linear unit [mm]
- delta\_max: Maximum permissible deflection of the linear unit [mm]
- F: Applied force [N]
- L0: Unsupported profile length [mm]

The maximum permissible deflection delta\_max must not be exceeded. In the case that maximum deflection delta exceeds the maximum permissible deflection delta\_max additional profile supports are needed.

## Deflection of the linear unit

### MTJZ 80

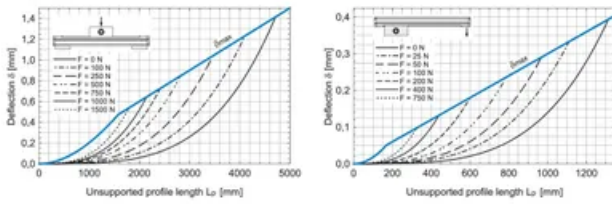

- 1. The linear units do not include any safety stroke.
- Absolute stroke = Effective stroke + 2 x safety stroke.

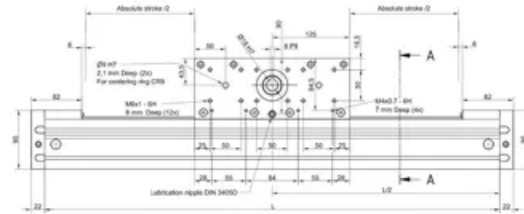

- 1. All dimensions in mm. Drawings scales are not equal.

- 1. The linear units do not include any safety stroke.
- Absolute stroke = Effective stroke + 2 x safety stroke.

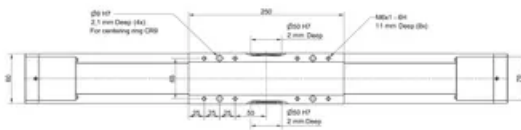

- 1. All dimensions in mm. Drawings scales are not equal.

### TYPE 0

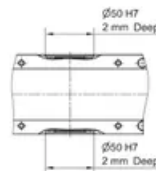
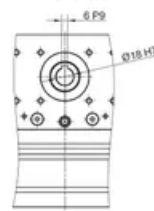

### TYPE 1

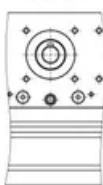

- 1. Journal with or without keyway.

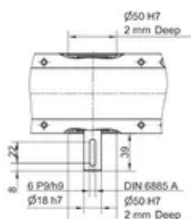

### TYPE 2

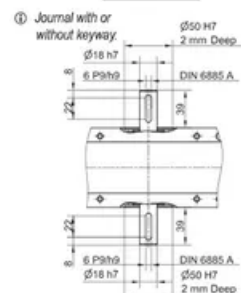

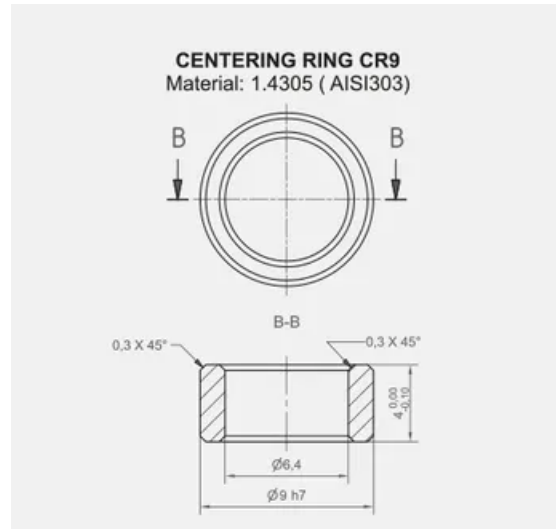
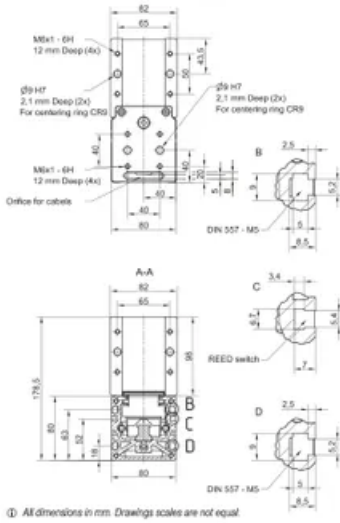

**Defining of the linear unit length**

$L = \text{Effective stroke} + 2 \times \text{Safety stroke} + 382 \text{ mm}$   
 $L_{\text{total}} = L + 44 \text{ mm}$

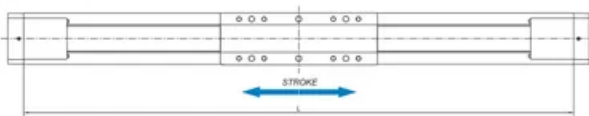

**Multi drive block**

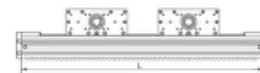

$L = \text{Effective stroke} + 2 \times \text{Safety stroke} + 250 \times n_b + 132 \text{ mm}$   
 $L_{\text{total}} = L + 44 \text{ mm}$   
 $n_b$  - number of drive blocks

**General Data**

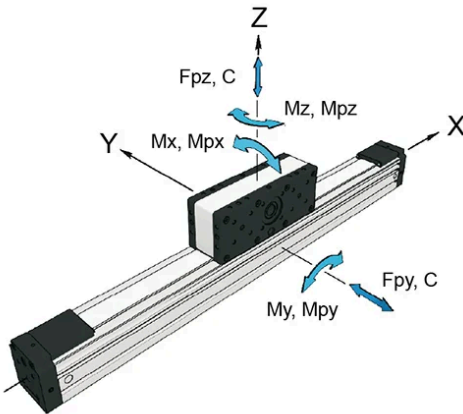

For minimum stroke below the stated value, please contact Rollco.

For length/stroke over the stated value, please contact Rollco. Values for max. stroke are not valid for multi drive box (equation of defining the linear unit length for particular size of the linear unit needs to be used).

**Recommended values of loads**

All the data of static and dynamic moments and load capacities stated are theoretical without considering any safety factor. The safety factor depends on the application and its requested safety. We recommend a minimum safety factor ( $f_s = 5.0$ ).

Version 1: Mounting by the drive block, profile travels

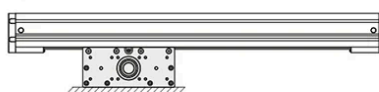

Version 2: Mounting by the profile, drive block travels

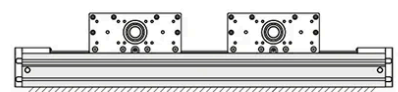

On request, multi drive blocks, which travel independently of each other, can be applied.

Designation	Dynamic Load Capacity C (N)	Static Load Capacity C0 (N)	Dynamic Moment Mx (Nm)	Dynamic Moment My (Nm)	Dynamic Moment Mz (Nm)
MTJZ 80	34200	60000	370	2565	2565

Designation	Mass of Drive Block (kg)	Max. Permissible Loads Forces Fpy (N)	Max. Permissible Loads Forces Fpz (N)	Max. Permissible Loads Moments Mpx (Nm)	Max. Permissible Loads Moments Mpy (Nm)	Max. Permissible Loads Moments Mpz (Nm)
MTJZ 80	4.9	8930	7130	150	535	670

Designation	Max. Repeatability (mm)	Max. Length Version 1 Lmax (mm)	Max. Length Version 2 Lmax (mm)	Max. Stroke Version 1 (mm)	Max. Stroke Version 2 (mm)	Min. Stroke (mm)
MTJZ 80	± 0.08	1500	6000	1118	5618	55

## Drive Data



Max. acceleration (m/s<sup>2</sup>): 70\*

For acceleration over the stated value, please contact Rolco.

Version 1: Mounting by the drive block, profile travels

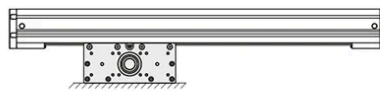

Version 2: Mounting by the profile, drive block travels

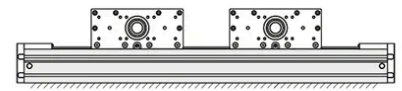

On request, multi drive blocks, which travel independently of each other, can be applied.

Designation	Max. Drive Torque (Nm)	Pulley Drive Ratio (mm/rev)	Pulley Diameter	Planar Moment of Inertia Iy (cm <sup>4</sup> )	Planar Moment of Inertia Iz (cm <sup>4</sup> )
MTJZ 80	29.4	210	66.84	129.1	173.4

Designation	Belt Type	Belt Width	Max. Force Transmitted by Belt (N)	Specific Spring Constant Cspec (N)
MTJZ 80	AT5	50	880	960000

## Mass and Mass Moment



Mass calculation does not include mass of motor, reduction gear, switches and clamps.

Version 1: Mounting by the drive block, profile travels

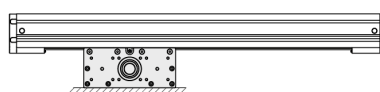

Version 2: Mounting by the profile, drive block travels

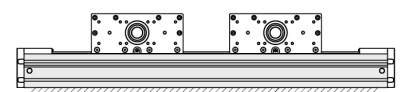

On request, multi drive blocks, which travel independently of each other, can be applied.

Abs. stroke	Absolute stroke [mm]
A	Distance between two drive blocks [mm]
nb	Number of drive blocks

Designation	Mass of Linear Unit (kg)	Mass Moment of Inertia Version 1 (10 <sup>-4</sup> kg m <sup>2</sup> )	Mass Moment of Inertia of Drive Block Version 2 (10 <sup>-4</sup> kg m <sup>2</sup> )	Planar Moment of Inertia Iy (cm <sup>4</sup> )	Planar Moment of Inertia Iz (cm <sup>4</sup> )
MTJZ 80	9.7 + 0.0083 × (Abs. Stroke + (nb - 1) × A) + 4.9 × (nb - 1)	60.0 + 0.0922 × (Abs. Stroke + (nb - 1) × A) + 6.4 × (nb - 1)	61.1	129.1	173.4