

Linear Unit CTV 110

The CTV series describes linear units with a precision ball screw drive and two parallel, integrated, zero backlash rail guides. In the linear units CTV a precision ball screw, with tolerance class ISO7 (ISO5 on request), with reduced backlash of the ball nut is used.

Two parallel circulating antistatic polyurethane sealing strips and an aluminum cover are ensuring to protect all the parts in the profile from dust and other contaminations. Re-lubrication can be done through maintenance holes on the side of the profile.

Modulus of Elasticity: $E = 70000 \text{ N / mm}^2$

Operating Temperature (°C): 0 ~ +60 For operating temperature out of the presented range, please contact Rollco.

Duty Cycle: 100%

Max. Acceleration (m/s²): 20





1. Drive block with floating bearing
2. Gap-type seal of antistatic PU strip (recirculating)
3. Ball screw tolerance ISO7 (ISO5 available on request)
4. Carriage; with built in magnets
5. Aluminium cover
6. Aluminium profile - hard anodized
7. Two integrated linear ball guideways
8. Central lubrication port, both sides
9. End block with fixed bearing

Deflection of the linear unit

CTV

Fixed - fixed mounting

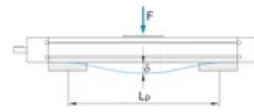

A Maximum deflection of the linear unit [mm]
 linear Maximum permissible deflection of the linear unit [mm]
 F Applied force [N]
 Lp Unsupported profile length [mm]

Fixed - free mounting

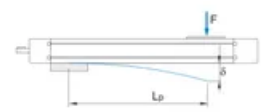

The maximum permissible deflection (linear) must not be exceeded. In the case that maximum deflection (delta) exceeds the maximum permissible deflection (linear) additional profile supports are needed.

Deflection of the linear unit

CTV 110

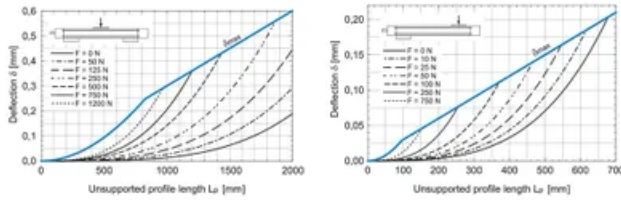

① The linear units do not include any safety stroke. Absolute stroke = Effective stroke + 2 x safety stroke.

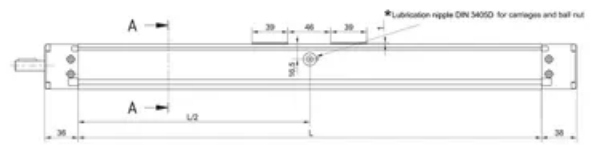

* Lubrication part position:
 Long carriage L/2
 Short carriage L/2 - 39 mm

① Journal with or without keyway. ② All dimensions in mm. Drawings scales are not equal.

① The linear units do not include any safety stroke. Absolute stroke = Effective stroke + 2 x safety stroke.

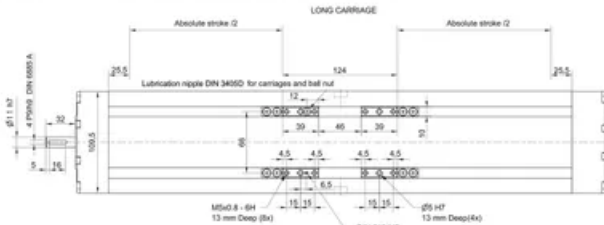

① Journal with or without keyway. ② All dimensions in mm. Drawings scales are not equal.

① The linear units do not include any safety stroke. Absolute stroke = Effective stroke + 2 x safety stroke.

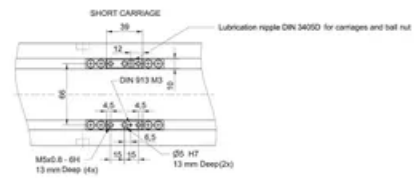

① Journal with or without keyway. ② All dimensions in mm. Drawings scales are not equal.

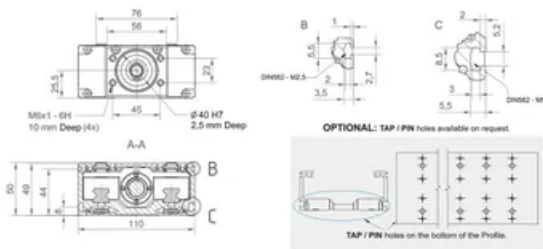

① Journal with or without keyway. ② All dimensions in mm. Drawings scales are not equal.

Defining of the linear unit length

$$L = \text{Effective stroke} + 2 \times \text{Safety stroke} + L_v + 51 \text{ mm}$$

$$L_{\text{total}} = L + 74 \text{ mm}$$

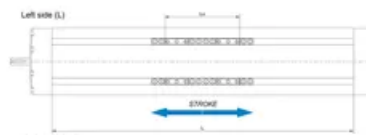

Lv - Long carriage = 124 mm
 Lv - Short carriage = 39 mm

$$L = \text{Effective stroke} + 2 \times \text{Safety stroke} + A + 90 \text{ mm}$$

$$L_{\text{total}} = L + 74 \text{ mm}$$

A ≥ 85 mm

Double-Carriage

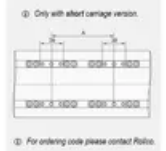

① Only with short carriage version.
 ② For ordering code please contact Rollco.

Connection plate

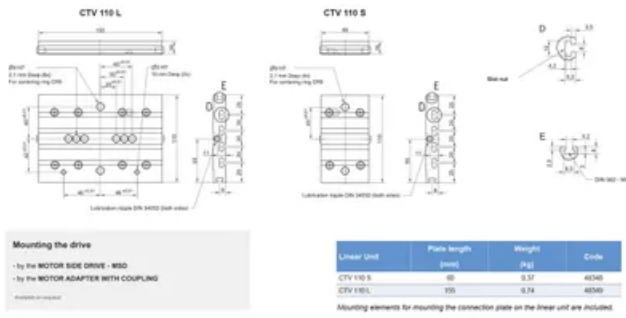

Maximum travel speed as a function of the profile length (vmax - L curves)

CTV 110

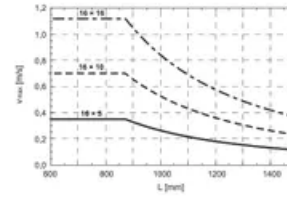

General data

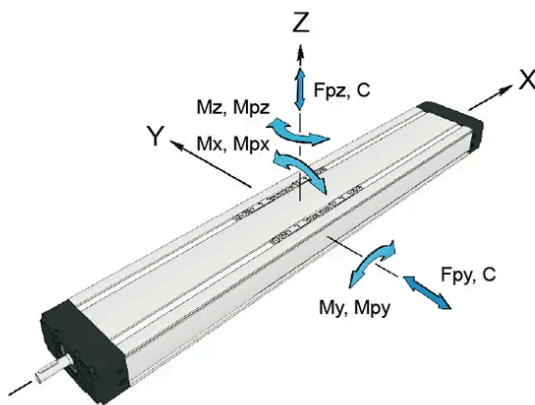

For length/stroke over the stated value, please contact Rollco. Values for max. stroke are not valid for double carriage (equation of defining the linear unit length for particular size of the linear unit needs to be used).

Recommended values of loads

All the data of static and dynamic moments and load capacities stated are theoretical without considering any safety factor. The safety factor depends on the application and its requested safety. We recommend a minimum safety factor ($f_s = 5.0$).

Designation	Carriage Length L_v (mm)	Dynamic Moment M_x (Nm)	Dynamic Moment M_y (Nm)	Dynamic Moment M_z (Nm)	Dynamic Load Capacity C (N)
CTV 110 S - 16 x 5	39	650	118	235	19800
CTV 110 S - 16 x 10	39	650	118	235	19800
CTV 110 S - 16 x 16	39	650	118	235	19800
CTV 110 L - 16 x 5	124	1305	1680	1680	39600
CTV 110 L - 16 x 10	124	1305	1680	1680	39600
CTV 110 L - 16 x 16	124	1305	1680	1680	39600

Designation	Static Load Capacity C_0 (N)	Max. Permissible Loads Forces F_{py} (N)	Max. Permissible Loads Forces F_{pz} (N)	Max. Permissible Loads Moments M_{px} (Nm)	Max. Permissible Loads Moments M_{py} (Nm)	Max. Permissible Loads Moments M_{pz} (Nm)
CTV 110 S - 16 x 5	35000	4670	9390	310	90	90
CTV 110 S - 16 x 10	35000	4670	9390	310	90	90
CTV 110 S - 16 x 16	35000	4670	9390	310	90	90
CTV 110 L - 16 x 5	70000	13080	18800	620	800	550
CTV 110 L - 16 x 10	70000	13080	18800	620	800	550
CTV 110 L - 16 x 16	70000	13080	18800	620	800	550

Designation	Moved Mass (kg)	Max. Length L_{max} (mm)	Max. Stroke (mm)	Min. Stroke (mm)
CTV 110 S - 16 x 5	0.63	1500	1410	40
CTV 110 S - 16 x 10	0.63	1500	1410	40
CTV 110 S - 16 x 16	0.63	1500	1410	40

Designation	Moved Mass (kg)	Max. Length Lmax (mm)	Max. Stroke (mm)	Min. Stroke (mm)
CTV 110 L - 16 x 5	1.36	1500	1325	40
CTV 110 L - 16 x 10	1.36	1500	1325	40
CTV 110 L - 16 x 16	1.36	1500	1325	40

General data double carriage

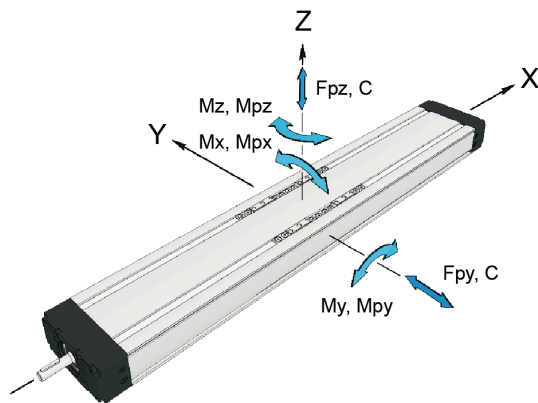

Mass calculation does not include mass of motor, reduction gear, switches and clamps.

Abs. stroke	Absolute stroke [mm]
A	Distance between carriages [mm]
nc	Number of carriages

Designation	Carriage version	Dynamic Load Capacity C (N)	Static Load Capacity C0 (N)	Dynamic Moment Mx (Nm)	Dynamic Moment My (Nm)
CTV 110 S - 16 x 5	S2 (S)	39600	70000	1300	$19.8 \times A$ (mm)
CTV 110 S - 16 x 10	S2 (S)	39600	70000	1300	$19.8 \times A$ (mm)
CTV 110 S - 16 x 16	S2 (S)	39600	70000	1300	$19.8 \times A$ (mm)
CTV 110 L - 16 x 5	S2 (L)	39600	70000	1300	$19.8 \times A$ (mm)
CTV 110 L - 16 x 10	S2 (L)	39600	70000	1300	$19.8 \times A$ (mm)
CTV 110 L - 16 x 16	S2 (L)	39600	70000	1300	$19.8 \times A$ (mm)

Designation	Dynamic Moment Mz (Nm)	Max. Permissible Loads Forces Fpy (N)	Max. Permissible Loads Forces Fpz (N)	Max. Permissible Loads Moments Mpx (Nm)	Max. Permissible Loads Moments Mpy (Nm)	Max. Permissible Loads Moments Mpz (Nm)
CTV 110 S - 16 x 5	$19.8 \times A$ (mm)	12940	18790	620	$9.4 \times A$ (mm)	$6.5 \times A$ (mm)
CTV 110 S - 16 x 10	$19.8 \times A$ (mm)	12940	18790	620	$9.4 \times A$ (mm)	$6.5 \times A$ (mm)
CTV 110 S - 16 x 16	$19.8 \times A$ (mm)	12940	18790	620	$9.4 \times A$ (mm)	$6.5 \times A$ (mm)
CTV 110 L - 16 x 5	$19.8 \times A$ (mm)	12940	18790	620	$9.4 \times A$ (mm)	$6.5 \times A$ (mm)
CTV 110 L - 16 x 10	$19.8 \times A$ (mm)	12940	18790	620	$9.4 \times A$ (mm)	$6.5 \times A$ (mm)
CTV 110 L - 16 x 16	$19.8 \times A$ (mm)	12940	18790	620	$9.4 \times A$ (mm)	$6.5 \times A$ (mm)

Drive data

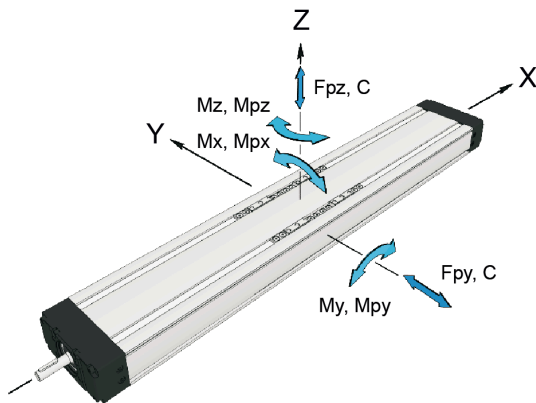

Max. travel speed depends of the length of the linear unit, see diagram for particular size of the linear unit. For travel speed over the stated value, please contact Rollco.

The stated values are for strokes up to 500 mm. No load torque value increases with stroke elongation.

For the ball nut with the preload of 2%, please contact Rollco.

For minimum stroke below the stated value, please contact Rollco.

Max. acceleration (m/s²): 20

For acceleration over the stated value, please contact Rollco.

Reduced effective diameter at journal with keyway decreases values of max. drive torque. See Max. Drive torque values in table below.

nc = Number of carriages

Designation	Max. Travel Speed (m/s)	Max. Rotational Speed (rev/min)	Max. Drive Torque Ma (Nm)	Lead Constant (mm/rev)	No Load Torque Carriage S (Nm)
CTV 110 S - 16 x 5	0.35	4200	5,5 (w. keyway), 7,7 (w.o keyway)	5	0.17 × nc
CTV 110 S - 16 x 10	0.7	4200	5,5 (w. keyway), 11,9 (w.o keyway)	10	0.18 × nc
CTV 110 S - 16 x 16	1.12	4200	5,5 (w. keyway), 11,9 (w.o keyway)	16	0.23 × nc
CTV 110 L - 16 x 5	0.35	4200	5,5 (w. keyway), 7,7 (w.o keyway)	5	0.17 × nc
CTV 110 L - 16 x 10	0.7	4200	5,5 (w. keyway), 11,9 (w.o keyway)	10	0.18 × nc
CTV 110 L - 16 x 16	1.12	4200	5,5 (w. keyway), 11,9 (w.o keyway)	16	0.23 × nc

Designation	No Load Torque Carriage L (Nm)	Ball Screw (d x l)	Max. Repeatability Precision Standard ISO7	Max. Repeatability Precision ISO5	Dynamic Load Capacity BS Ca (N)	Max. Axial Load Fx (N)
CTV 110 S - 16 x 5	0.20 × nc	16 × 5	± 0.02	± 0.01	13150	8700
CTV 110 S - 16 x 10	0.21 × nc	16 × 10	± 0.02	± 0.01	11550	6730
CTV 110 S - 16 x 16	0.26 × nc	16 × 16	± 0.02	± 0.01	8170	4200
CTV 110 L - 16 x 5	0.20 × nc	16 × 5	± 0.02	± 0.01	13150	8700
CTV 110 L - 16 x 10	0.21 × nc	16 × 10	± 0.02	± 0.01	11550	6730
CTV 110 L - 16 x 16	0.26 × nc	16 × 16	± 0.02	± 0.01	8170	4200

Designation	Planar Moment of Inertia Iy (cm ⁴)	Planar Moment of Inertia Iz (cm ⁴)
CTV 110 S - 16 x 5	29.1	196
CTV 110 S - 16 x 10	29.1	196
CTV 110 S - 16 x 16	29.1	196
CTV 110 L - 16 x 5	29.1	196
CTV 110 L - 16 x 10	29.1	196
CTV 110 L - 16 x 16	29.1	196

Mass and Mass moment

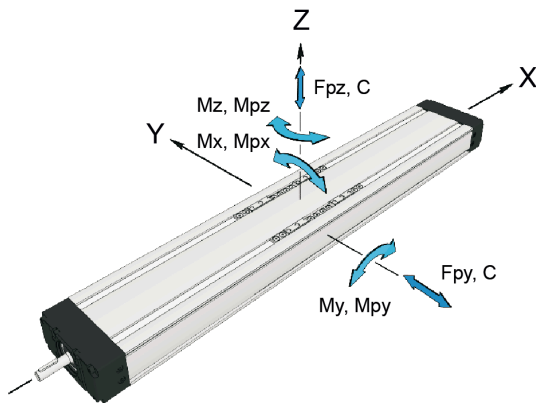

Mass calculation does not include mass of motor, reduction gear, switches and clamps.

Abs. stroke	Absolute stroke [mm]
A	Distance between carriages [mm]
nc	Number of carriages

Designation	Ball Screw (d x l)	Mass of Linear Unit (kg)	Mass Moment of Inertia (10 ⁻⁵ kg m ²)	Planar Moment of Inertia Iy (cm ⁴)	Planar Moment of Inertia Iz (cm ⁴)
CTV 110 S - 16 x 5	16 x 5	$3.3 + 0.008 \times (\text{Abs. Stroke} + (\text{nc} - 1) \times A) + 0.63 \times (\text{nc} - 1)$	$0.70 + 0.005 \times (\text{Abs. Stroke} + (\text{nc} - 1) \times A) + 0.04 \times (\text{nc} - 1)$	29.1	196
CTV 110 S - 16 x 10	16 x 10	$3.3 + 0.008 \times (\text{Abs. Stroke} + (\text{nc} - 1) \times A) + 0.63 \times (\text{nc} - 1)$	$0.82 + 0.005 \times (\text{Abs. Stroke} + (\text{nc} - 1) \times A) + 0.16 \times (\text{nc} - 1)$	29.1	196
CTV 110 S - 16 x 16	16 x 16	$3.3 + 0.008 \times (\text{Abs. Stroke} + (\text{nc} - 1) \times A) + 0.63 \times (\text{nc} - 1)$	$1.07 + 0.005 \times (\text{Abs. Stroke} + (\text{nc} - 1) \times A) + 0.41 \times (\text{nc} - 1)$	29.1	196
CTV 110 L - 16 x 5	16 x 5	$4.6 + 0.008 \times (\text{Abs. Stroke} + (\text{nc} - 1) \times A) + 1.36 \times (\text{nc} - 1)$	$1.19 + 0.005 \times (\text{Abs. Stroke} + (\text{nc} - 1) \times A) + 0.09 \times (\text{nc} - 1)$	29.1	196
CTV 110 L - 16 x 10	16 x 10	$4.6 + 0.008 \times (\text{Abs. Stroke} + (\text{nc} - 1) \times A) + 1.36 \times (\text{nc} - 1)$	$1.45 + 0.005 \times (\text{Abs. Stroke} + (\text{nc} - 1) \times A) + 0.34 \times (\text{nc} - 1)$	29.1	196
CTV 110 L - 16 x 16	16 x 16	$4.6 + 0.008 \times (\text{Abs. Stroke} + (\text{nc} - 1) \times A) + 1.36 \times (\text{nc} - 1)$	$1.99 + 0.005 \times (\text{Abs. Stroke} + (\text{nc} - 1) \times A) + 0.88 \times (\text{nc} - 1)$	29.1	196

Designation	Moved Mass (kg)
CTV 110 S - 16 x 5	0.63
CTV 110 S - 16 x 10	0.63
CTV 110 S - 16 x 16	0.63
CTV 110 L - 16 x 5	1.36
CTV 110 L - 16 x 10	1.36
CTV 110 L - 16 x 16	1.36