

210 Non Lock - 100% Extension

A precision ball bearing slide with smooth movement combined with good load carrying capacity. All aluminium slide.

A row of ball bearings in each track, concealed in nylon cages, ensures smooth and easy operation. Carrying loads up to 90 kg per pair.

Standard lengths 300 to 600 mm in 50 mm increments.

All dimensions in mm.

System Load Capacity value refers to a pair of rails at full extension.

Note 1: 15 mm dia. holes in centre beam allow easy access to fixing holes. M5 countersunk head screws to BS4183 are recommended for fixing.

Note 2: Elongated holes should be provided in either the framework or chassis to give adjustment if it is necessary for the panel to fit tight against the framework.

Material: Aluminium with steel ball bearings, standard anodizing finish silver.

Extension: 100%



General Data

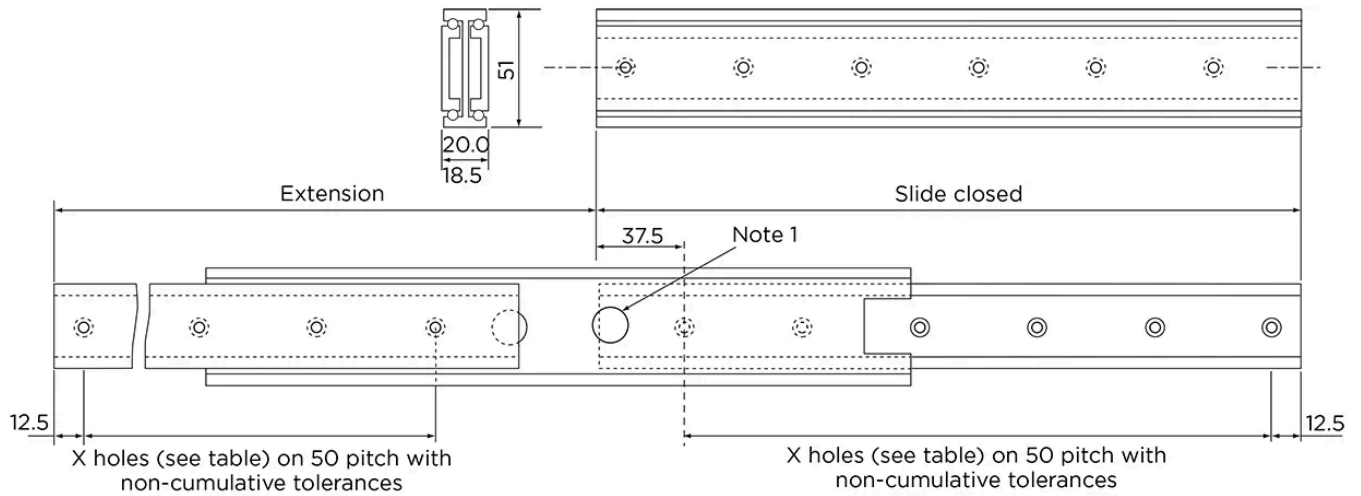

Note 1: 15 mm dia. holes in centre beam allow easy access to fixing holes. M5 countersunk head screws to BS4183 are recommended for fixing.

Note 2: Elongated holes should be provided in either the framework or chassis to give adjustment if it is necessary for the panel to fit tight against the framework.

Designation	Closed Length	Extension Length	System Load Capacity (N)	Number of Fixing Holes	Weight/pc (kg)
210-300	300	330	550	6	0.46
210-350	350	380	620	7	0.53
210-400	400	430	710	8	0.62
210-450	450	480	780	9	0.71
210-500	500	530	840	10	0.78
210-550	550	580	880	11	0.86
210-600	600	630	900	12	0.94